

**Eco Preparation
Corner Work Table with Upstand -
disassembled**

ITEM # _____

MODEL # _____

NAME # _____

SIS # _____

AIA # _____



132851 (CTUD7N)

Work Table disassembled
with upstand, 70mm,
Corner Type

Short Form Specification

Item No. _____

Worktop in 304 AISI stainless steel with upturned edges and under panel made of sound deadening material. Rear upstand h=100mm. Square section legs 40x40mm in 304 AISI stainless steel with adjustable feet. Delivered disassembled.

Main Features

- Sturdiness, stability and reliability of table accurately tested.

Construction

- Delivered in knock-down package.
- Constructed entirely in stainless steel to offer maximum durability.
- Wide range of taps are available to suit every need.

Optional Accessories

- Set of 4 wheels (2 with brake) PNC 855150
d. 100mm for tables and sinks
(total height on wheels= 993
mm)

APPROVAL: _____

Front

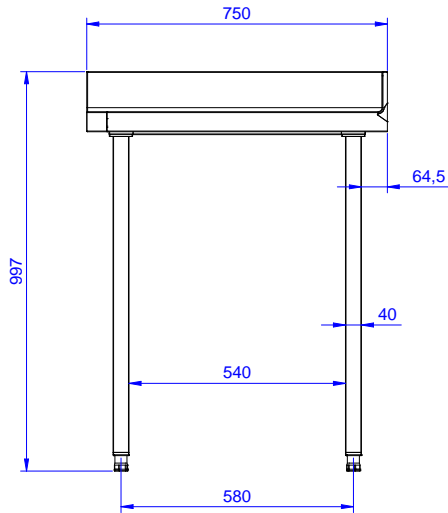

Side

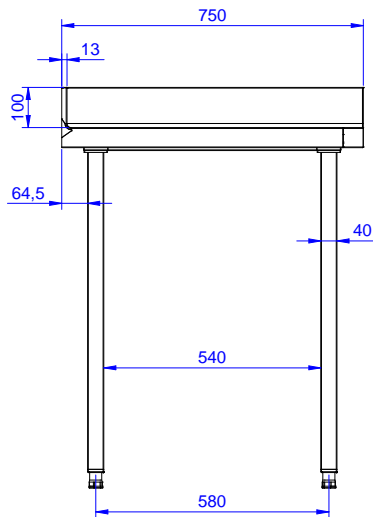

Top

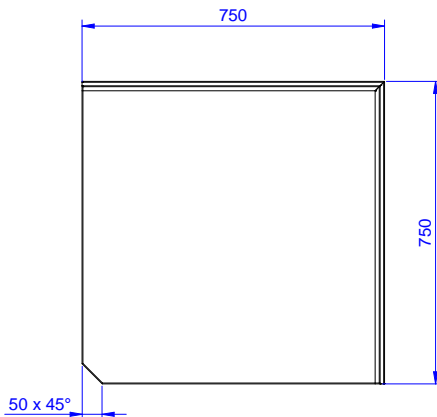
Key Information:

External dimensions, Width:	750 mm
132851 (CTUD7N)	750 mm
External dimensions, Depth:	750 mm
External dimensions, Height:	900 mm
Worktop thickness:	50 mm
Worktop/Shelf radius:	90°
Net weight:	33 kg